

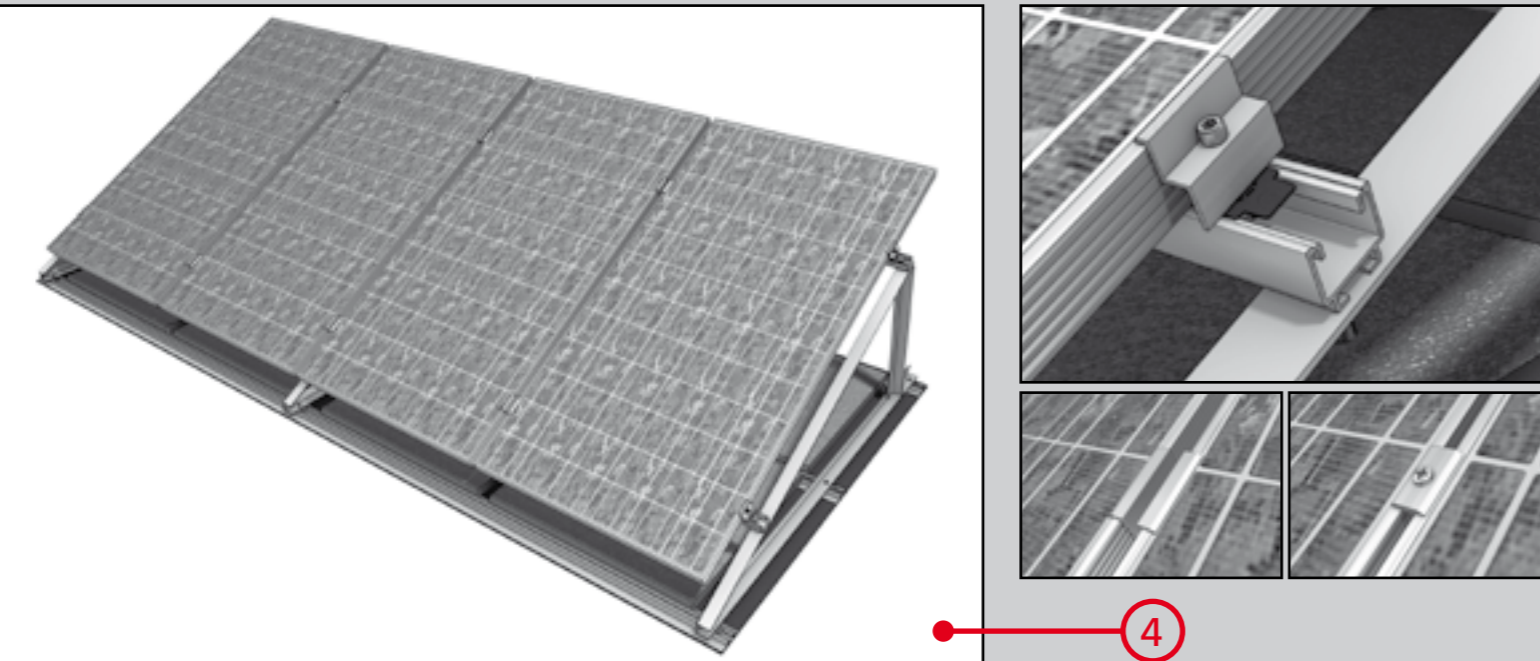

Montageanleitung Flachdach (Einlegesystem)



Bei Eingriffen in Bedachung oder Fassade sind die einschlägigen Bestimmungen des jeweiligen Landes einzuhalten.

Service-Hotline +49 (0)7033 46665-00

K2 Systems GmbH
Heimsheimer Strasse 69
71263 Weil der Stadt, Germany
Phone +49 (0)7033 46665-00
Fax +49 (0)7033 46665-09
info@k2-systems.de
www.k2-systems.de

Ihr Vertriebspartner:

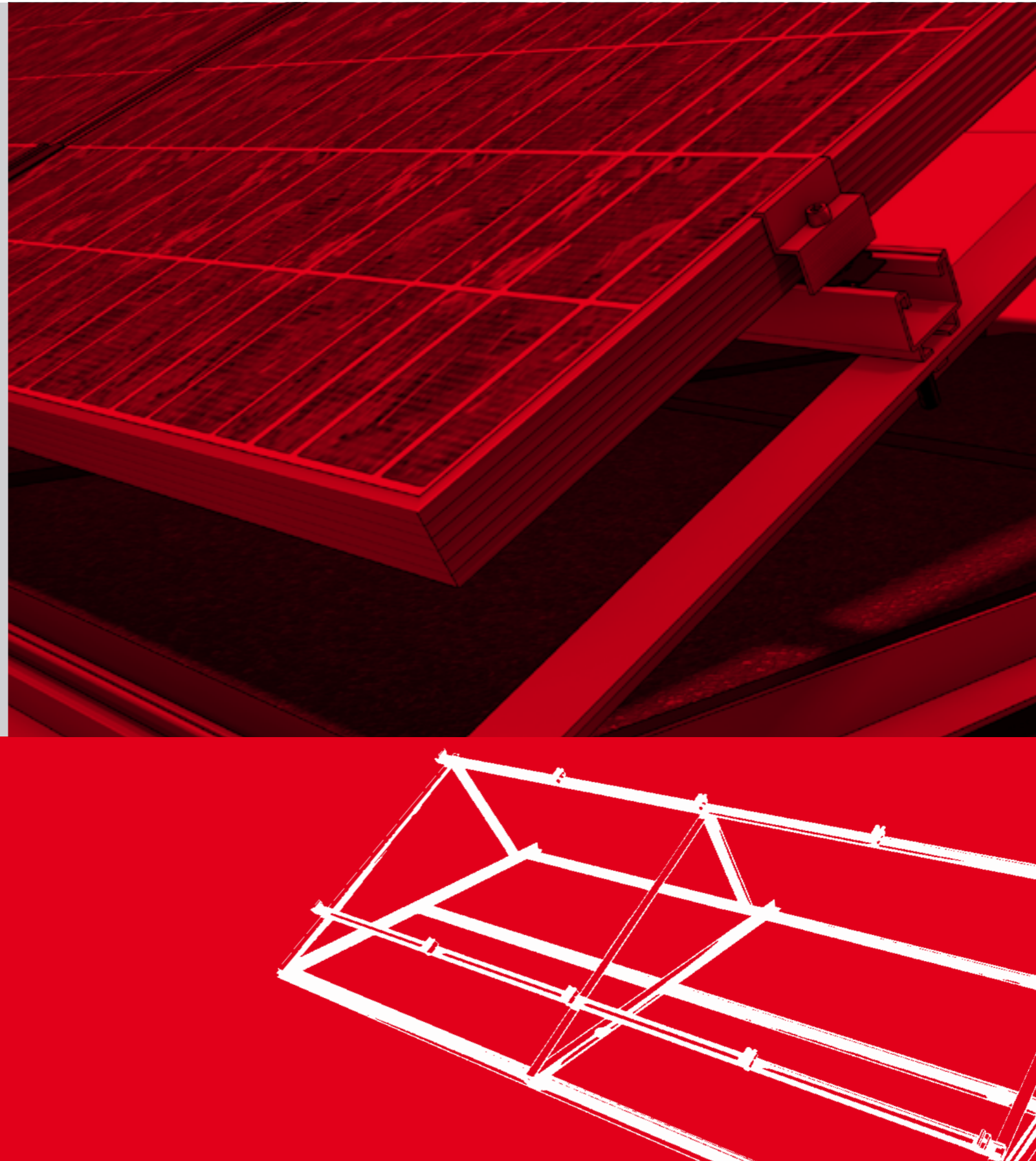
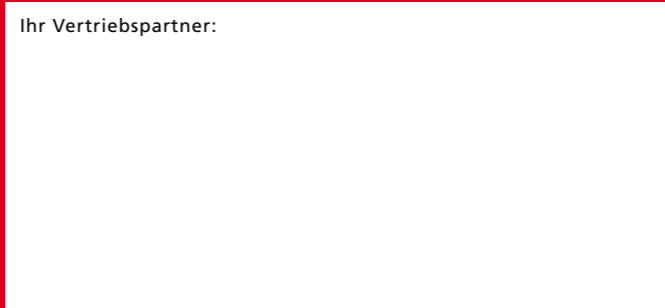

In wenigen Schritten fertig aufgebaut!

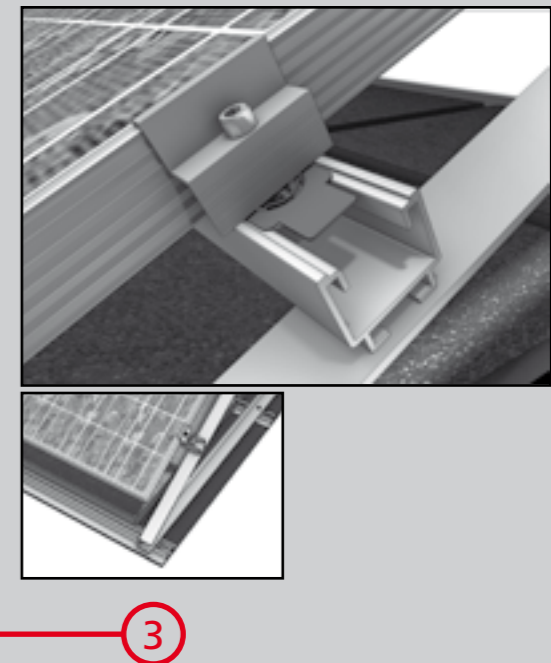
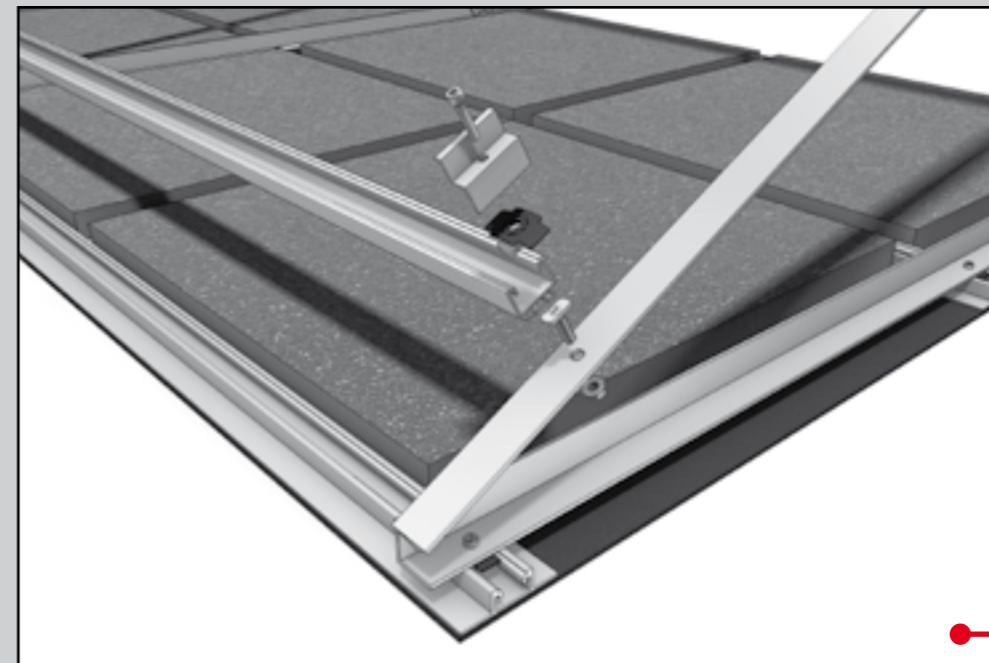
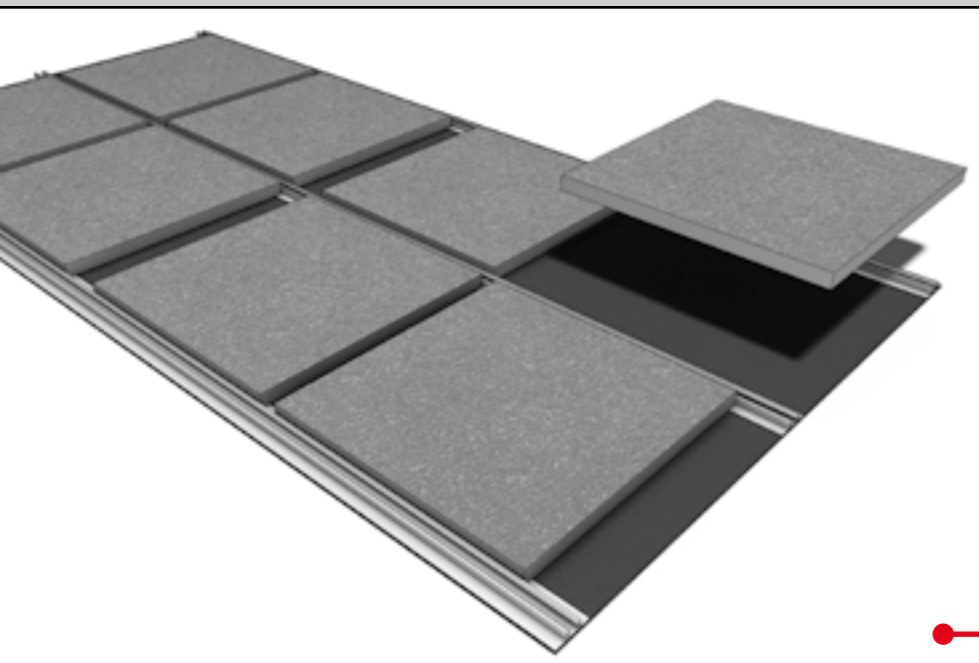
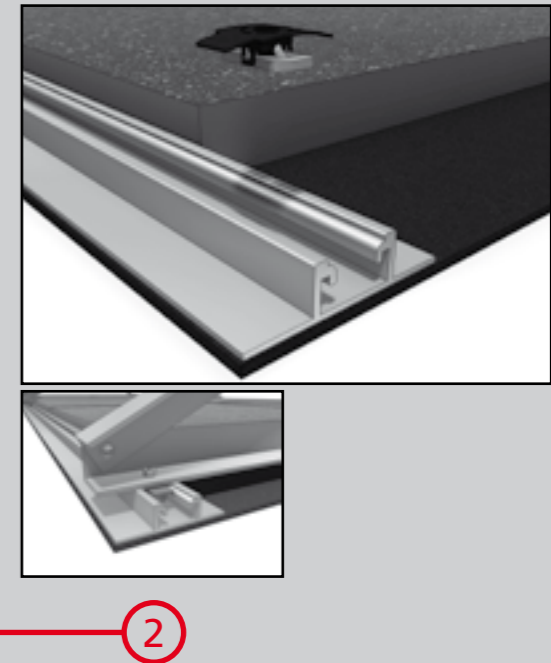
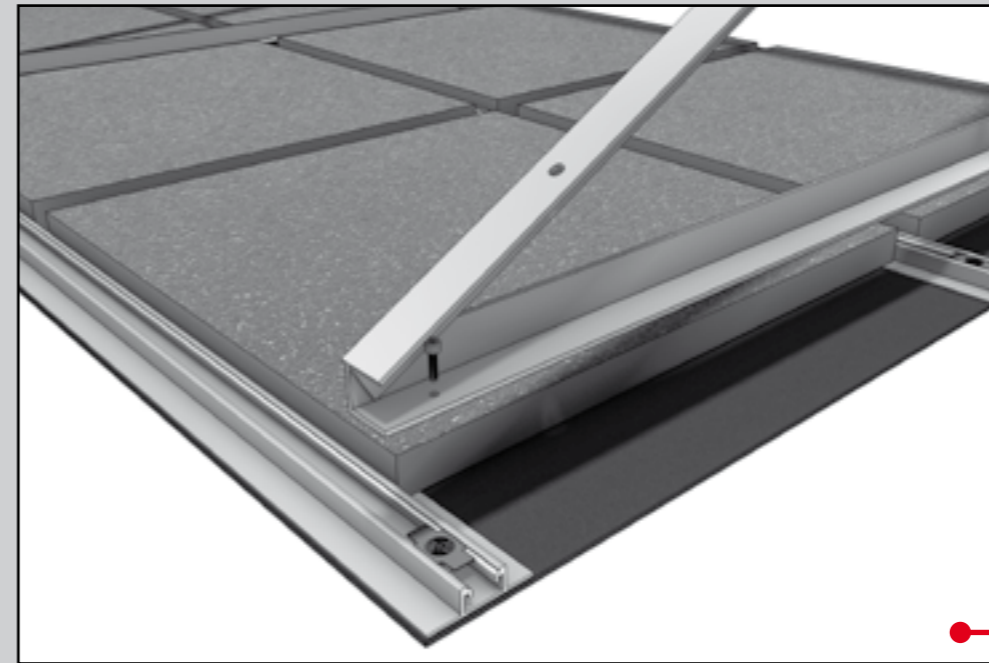
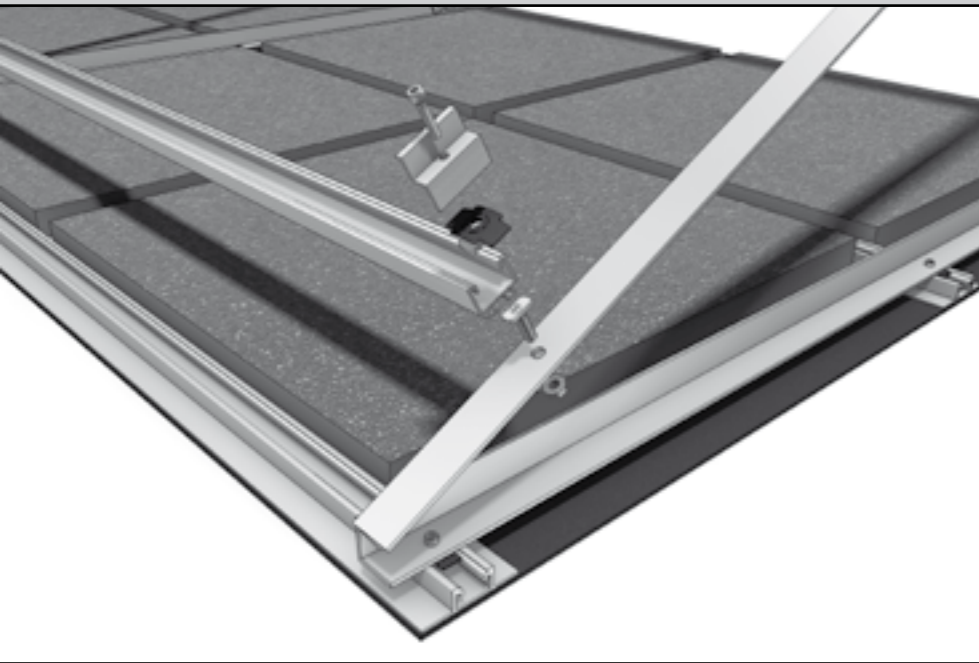

1

2

3

Empfohlenes Anzugsmoment metrischer Schrauben: M6: 4,6 Nm | M8: 11 Nm | M10: 22 Nm
Erdung muss hergestellt werden. Gegebenenfalls Blitzschutzklemme verwenden.
Empfohlenes Anzugsmoment Bohrschrauben: Ø 6,0 auf Anschlag ca. 5 Nm