

4

Bei Eingriffen in Bedachung oder Fassade sind die einschlägigen Bestimmungen des jeweiligen Landes einzuhalten.

**Service-Hotline +49 (0)7033 46665-00**

K2 Systems GmbH  
Heimsheimer Strasse 69  
71263 Weil der Stadt, Germany  
Phone +49 (0)7033 46665-00  
Fax +49 (0)7033 46665-09  
info@k2-systems.de  
www.k2-systems.de

Ihr Vertriebspartner:

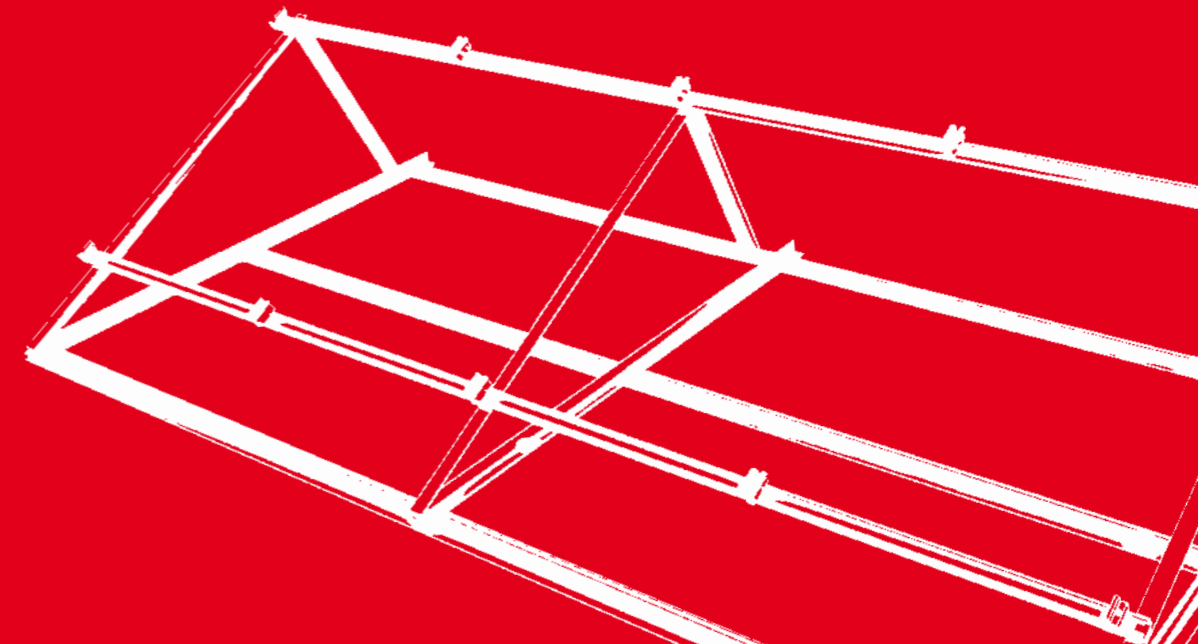
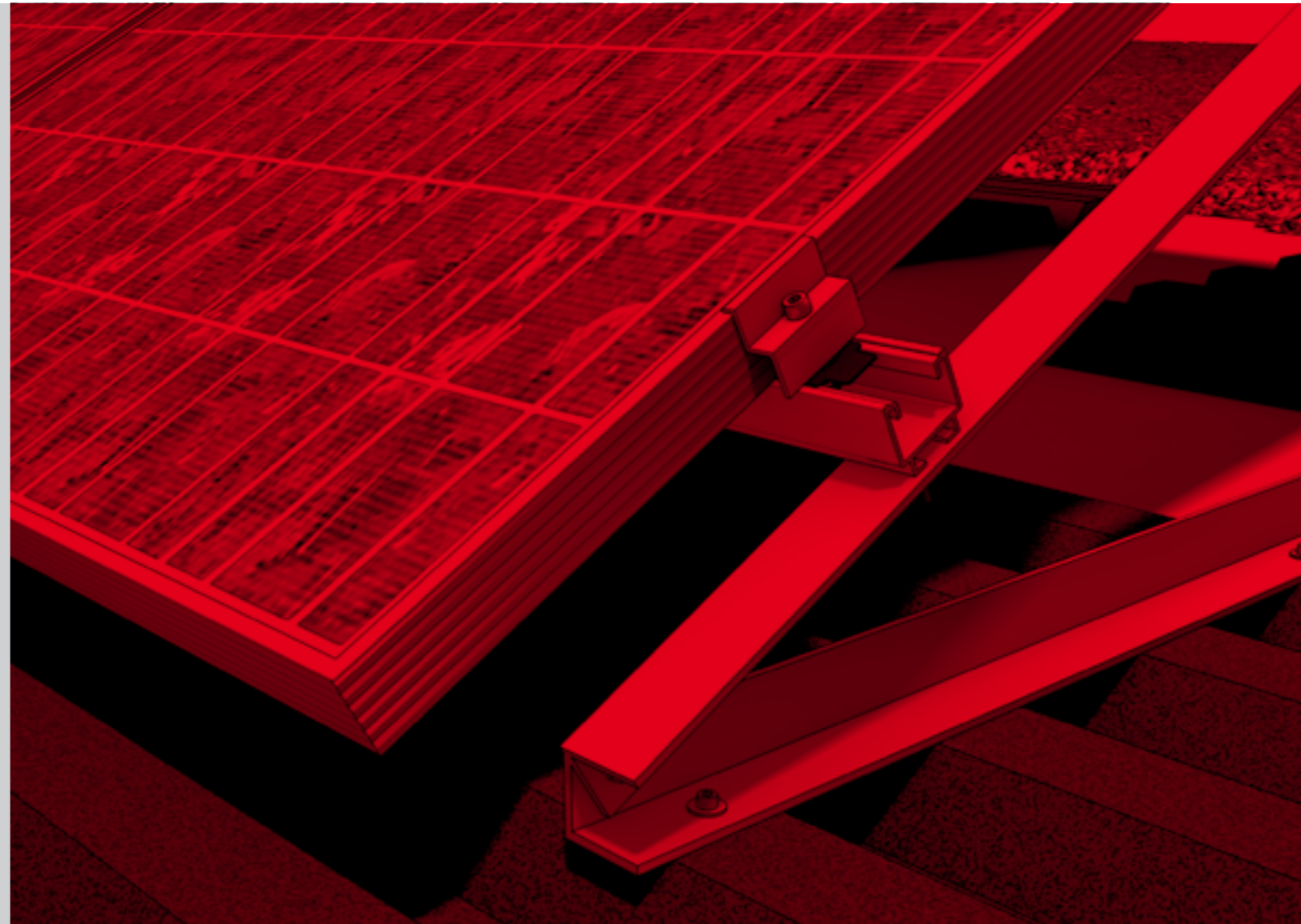
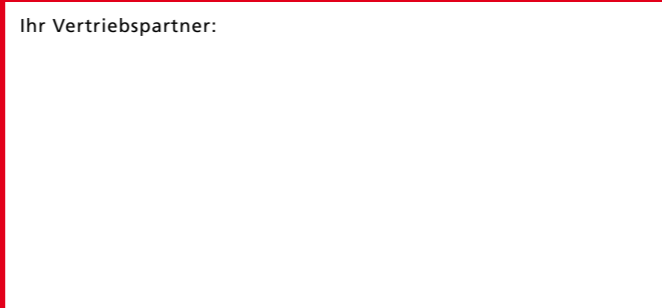

In wenigen Schritten fertig aufgebaut!

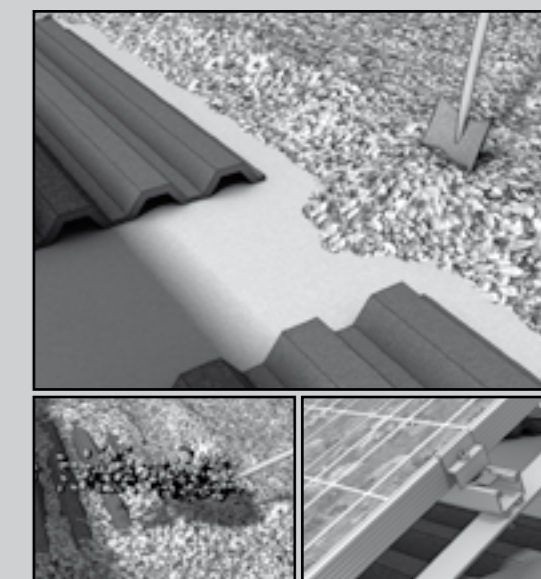
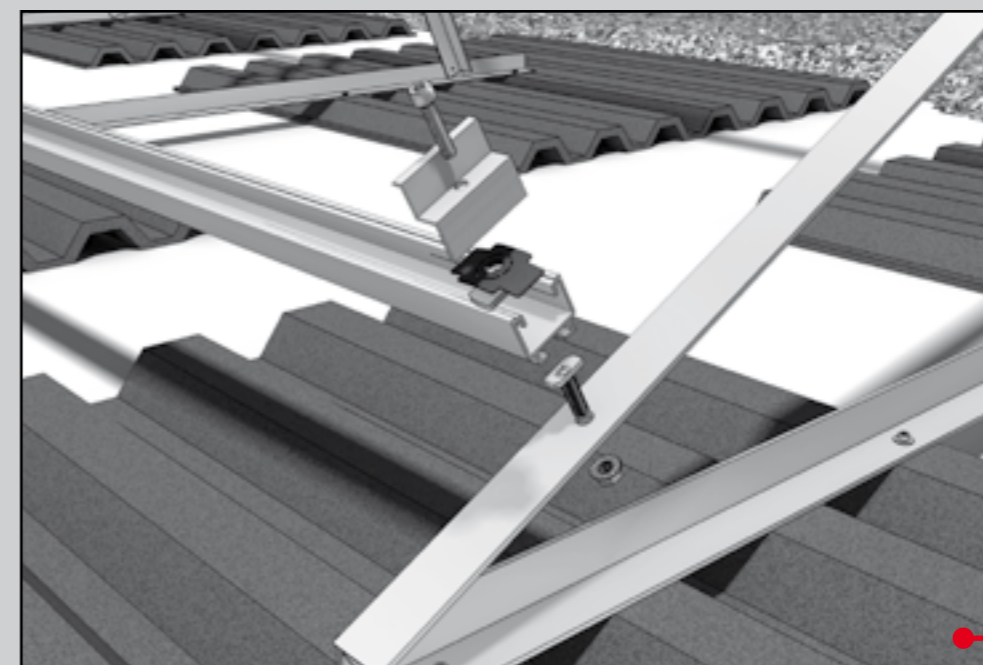
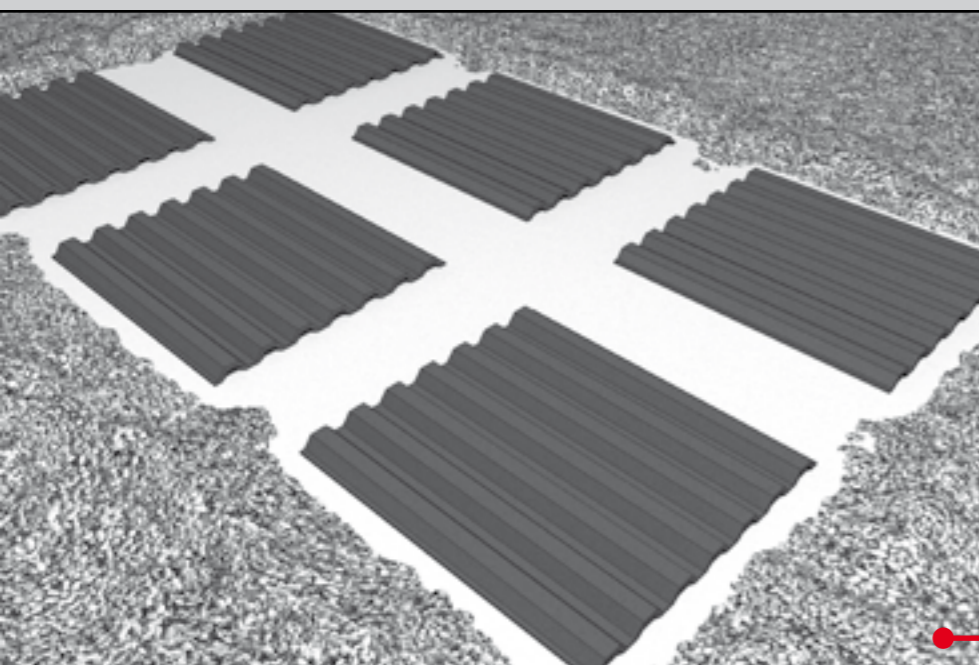
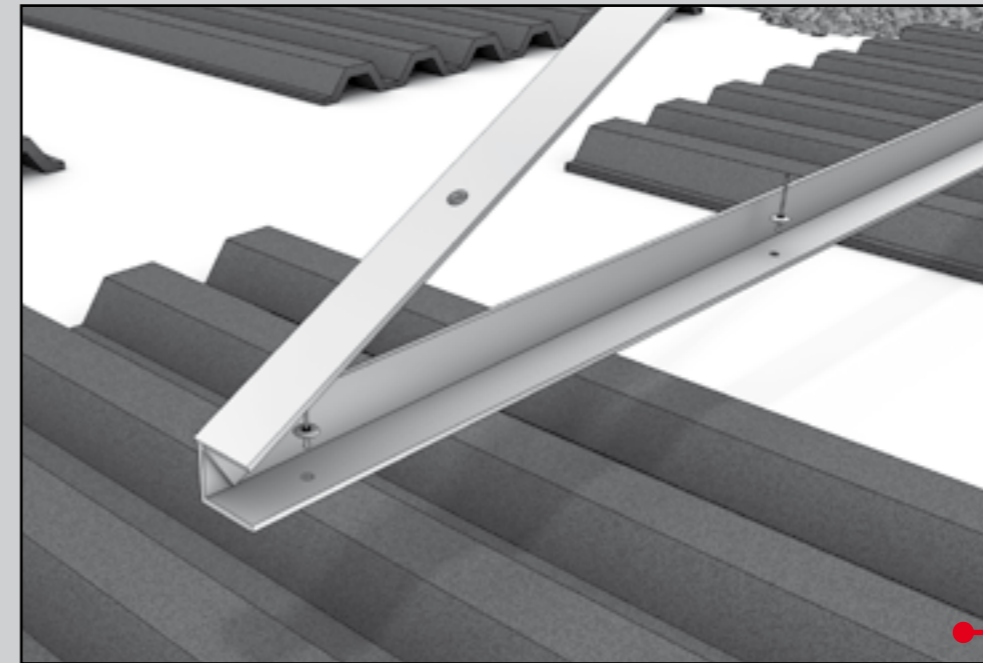
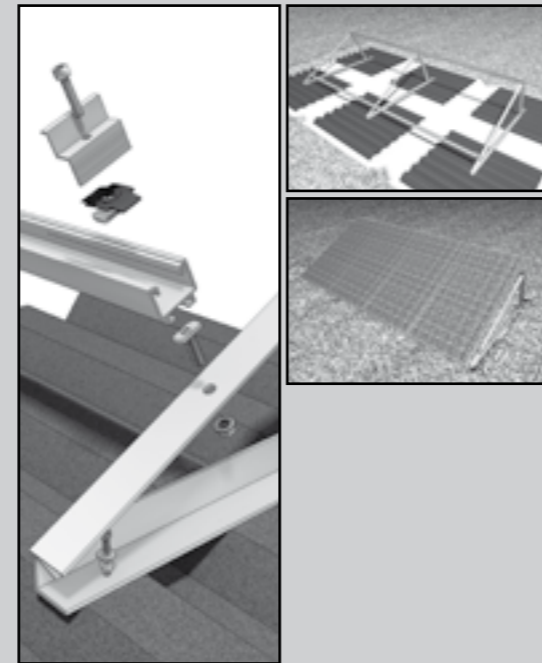
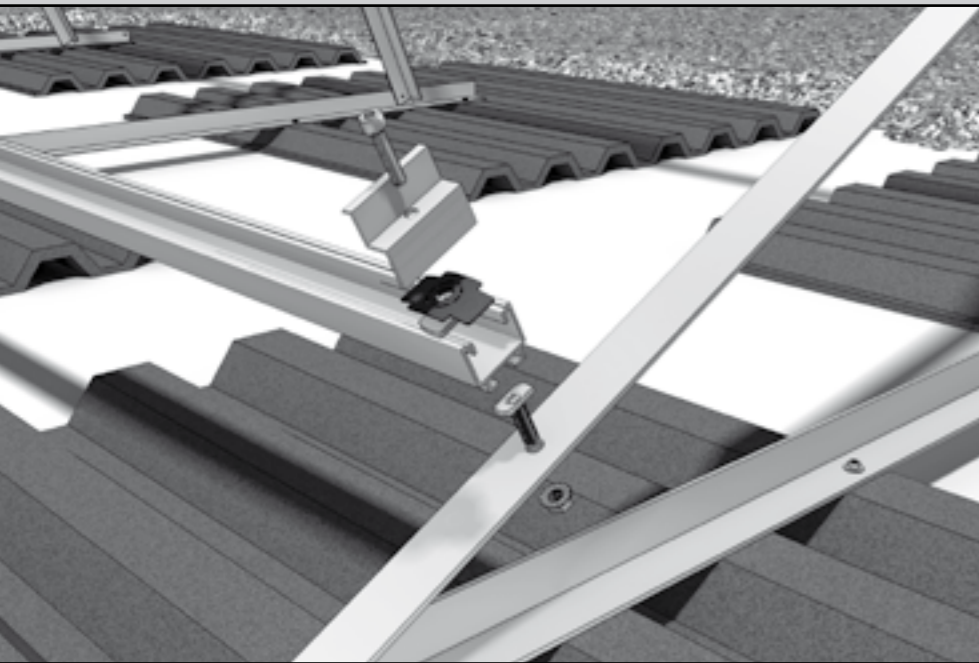

Empfohlenes Anzugsmoment metrischer Schrauben: M6: 4,6 Nm | M8: 11 Nm | M10: 22 Nm  
Erdung muss hergestellt werden. Gegebenenfalls Blitzschutzklemme verwenden.  
Empfohlenes Anzugsmoment Bohrschrauben: Ø 6,0 auf Anschlag ca. 5 Nm